

Article number: 25150465002

Description: ICME Single-phase motor MD90 L4 1,5KW
4 - 1400 rpm 1x230 Volt 50Hz B14 with starting & running capacitor

Measures

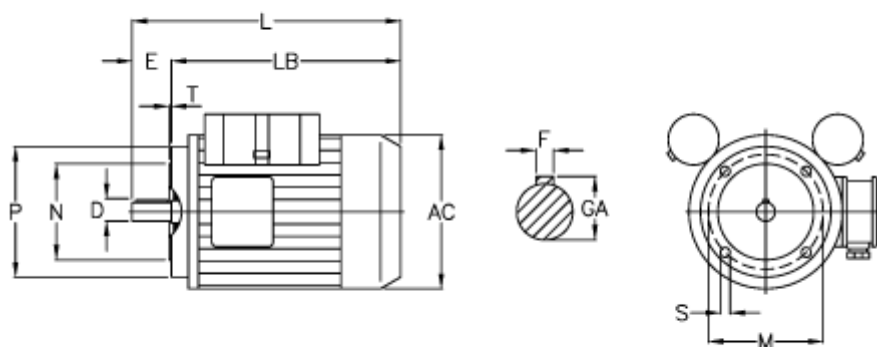

AC = 176	M = 115
D = 24	N = 95
E = 50	P = 140
F = 8	S = M8
GA = 27	T = 3
HB = 129	Z = 246
L = 366	
LB = 316	